

MD2130 Ultrasound Beamforming Transmitter Demoboard

Introduction

MD2130 is a high-speed, arbitrary waveform, push-pull source-driver. It is designed for medical ultrasound imaging and HIFU beamforming applications. It also can be used in NDT, sonar and other ultrasound phase-array focusing beamforming applications.

The integrated circuit (IC) consists of the CMOS digital logic input circuits, an 8-bit current DAC for the waveform amplitude control, and four PWM current-sources. These current sources are constructed with the high-speed in-phase and quadrature current-switch matrix and the built-in sine and cosine angle-to-vector look-up table. The angular resolution of the vector table is 7.5 degrees per step with a total range of 48 steps. There are four logic input signals to control the in-phase and quadrature PWM push-pull current-source's output timing frequency cycle in the burst and waveform envelope.

MD2130's output stage is designed to drive two depletion mode, high voltage, DN2625DK6 type MOSFETs as a sourcedriver. The MOSFET drains are connected to a center-tap ultrasound frequency pulse transformer. The secondary winding of the transformer can connect to the ultrasound piezo or capacitive transducer via cable with a good impedance match. MD2130 has a high-speed serial data interface that quickly updates the data register's per-scan-line for changing the beamforming phase angles and apodization amplitudes.

General Description

This demoboard data sheet describes how to use the MD2130DB3 to generate the ultrasound transmit beamforming waveform with the Gaussian profile, and the adjustable frequency, amplitude and phase angle. It also provides information about how to design a user application circuit and PCB using the MD2130 and DN2625 devices.

The MD2130DB3 circuit uses two depletion mode, high voltage, DN2625 MOSFETs in the push-pull mode to drive the center-tap wideband ultrasound output transformer. The MOSFETs are in a DK6 surface mount package. The sources of the MOSFETs are directly driven by MD2130's two outputs, whose maximum peak sinking current is up to 3A. These current-source outputs are controlled by the MD2130's internal angular vector switch matrix and the in-phase and quadrature PWM input signals.

All of the MD2130's logic control signals are generated by two small CPLD programmable logic circuits clocked by an on-board 160MHz crystal oscillator. The CPLD circuits not only generate accurate timing for the high-speed PWM control waveforms, but also the serial data and clock to set and change the waveform amplitude DAC and phase angle data registers. The external clock input can be used if the on-board oscillator is disabled. The external trigger input can be used to synchronize the burst waveforms' launch timing. There are five push buttons for enabling and selecting the output waveform frequency, phase angle and amplitude. Four color LEDs indicate the power, chip enable and waveform parameter selection states. The MD2130DB3 output

Demoboard Block Diagram

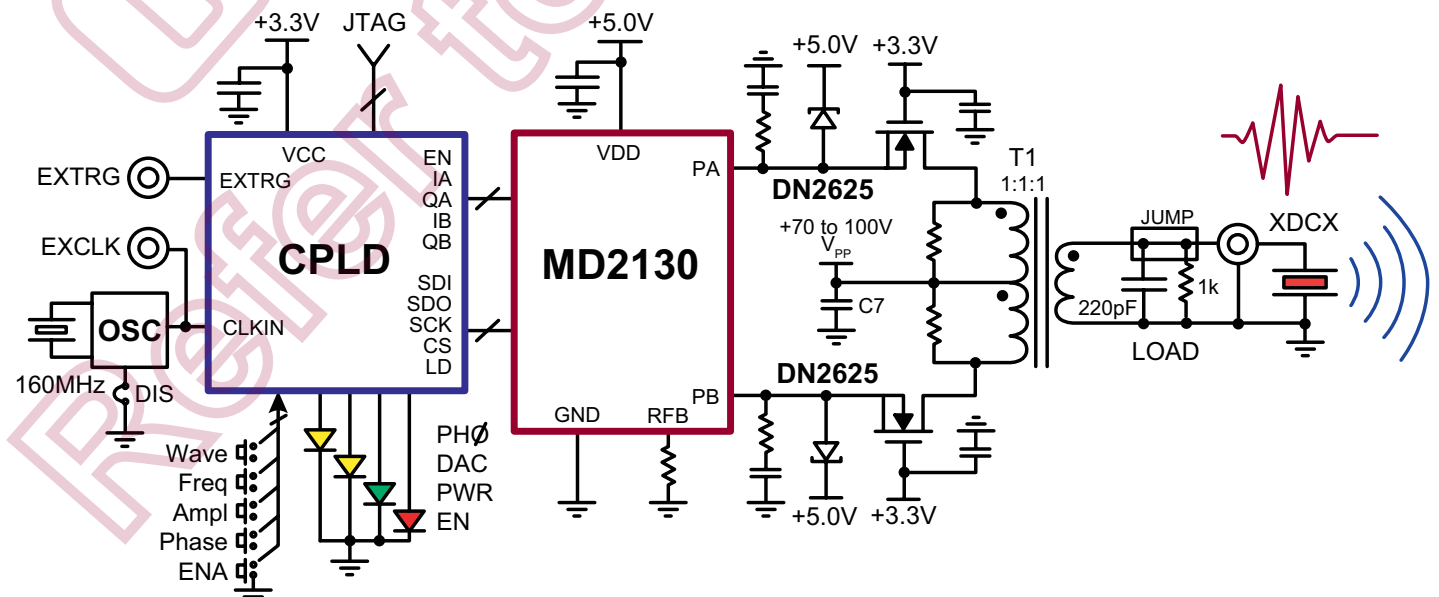

waveform can be displayed by using an oscilloscope and the high impedance probe at the TP13 test point. It also can use an SMA to BNC 50Ω coaxial cable to directly connect to an oscilloscope, with an attenuation of 5:1 if R10 is 200Ω. A cable can also be used to directly drive the user's transducer. Jumper J4 can be used to select whether or not to connect the on-board equivalent-load, which is formed by a 220pF capacitor in parallel with a 1kΩ resistor.

Circuit Design & PCB Layout

The thermal pad at the bottom of the MD2130 package must be connected to the VSUB pin on the PCB. The VSUB is connected to the IC's substrate. It is important to make sure that the VSUB is always, in any condition, at the highest potential of the IC circuit, even during the power-up or down periods. That is why a proper supply voltage power-up sequence is needed to test the circuit. To prevent any supply voltage polarity reversing, the circuit also has the protection of Schottky diodes D7, D8 and D9.

Due to the high current and high current slew rate nature of this common-gate, source-driven and push-pull circuit topology, the two cascading N-channel MOSFETs need to have very low lead inductance. The DN2625DK6 MOSFET is designed for this application and works seamlessly with the MD2130K7. In particular, a good PCB layout design needs to shorten the traces between the MD2130K7 output pins and DN2625DK6 source pins. It is also necessary to connect all three pairs of pins between them for the high current carrying capacity. Furthermore, because of the high di/dt in the output current of the MD2130, it is also necessary to have the Schottky diodes D5 and D6 from the driver output pins to the +5V power supply line as the clamping diodes. Note that the diodes must have enough speed and peak current capability. The RC snubber circuits of R8-C5 and R15-C28 at the output pins can dump the current pulse edge ringing effectively.

PCB designers need to pay attention to some of the connecting traces as high-voltage and high-speed traces. In particular, low capacitance to the ground plane and more trace spacing need to be applied in this situation.

High-speed PCB trace design practices that are compatible with operating speed of about 100 to 200 MHz are used for the demo board PCB layout. The internal circuitry of the MD2130 can operate at quite a high frequency, with the primary speed limitation being load capacitance. Because of this high speed, and the high transient currents that result when driving even very small inductive loads, ringing and even oscillations are possible. The supply voltage bypass

capacitors and the MOSFET gate de-coupling capacitors should be as close to the pins as possible. The capacitor's ground pin pads should have low inductance feed-through connections that are connected directly to a solid ground plane. The VDD and VPP supplies can draw fast transient currents of up to 3.5A, so they should be provided with a low-impedance bypass capacitor at the chip's pins. A ceramic capacitor of 0.1 to 1.0μF may be used. Minimize the trace length to the ground plane, and insert a ferrite bead in the power supply lead to the capacitor to prevent resonance in the power supply lines. For applications that are sensitive to jitter and noise and using multiple MD2130 ICs, insert another ferrite bead between VDD, and decouple each chip supply separately. Pay particular attention to minimizing trace lengths and using sufficient trace width to reduce inductance not only on the supply pins but also on the CA/B KA/B compensation pins. Very closely placed surface mount components are highly recommended. Be aware of the parasitic coupling from the high voltage outputs to the input signal terminals of MD2130. This feedback may cause oscillations or spurious waveform shapes on the edges of signal transitions. Since the input operates with signals down to 1.8V, even small coupling voltages may cause problems. The use of a solid ground plane and good power and signal layout practices will prevent this problem. Also ensure that the circulating ground return current from a capacitive load cannot react with common inductance to create noise voltages in the input logic circuitry.

This MD2130DB3 beamforming demoboard should be powered up with multiple DC power supplies with current limiting functions. The power supply voltages and current limits used in the testing are listed on page 7. There are examples of the MD2130DB3 demoboard input and output waveform and measurements shown in Figures 1 to 7.

Output Transformer Design

There is a center tap wideband ultrasound transformer needed for the push pull output circuit. The transformer serves at least three functions: the balanced differential to single-end RF output transformer; the isolation barrier to the ultrasound probe; and the impedance matching or low-pass network combined with the cable and transducer element. The MD2130 PWM clock may operate at a 40MHz to 160MHz frequency range, however the wideband transformer only needs to work in the frequency band of the ultrasound being transmitted. Beside the bandwidth consideration, the transformer also needs enough peak-current capacity and RF power coupling efficiency to make sure the ferrite magnetic core will not be saturated, have little leakage inductance and will be a small size.

Circuit Schematic

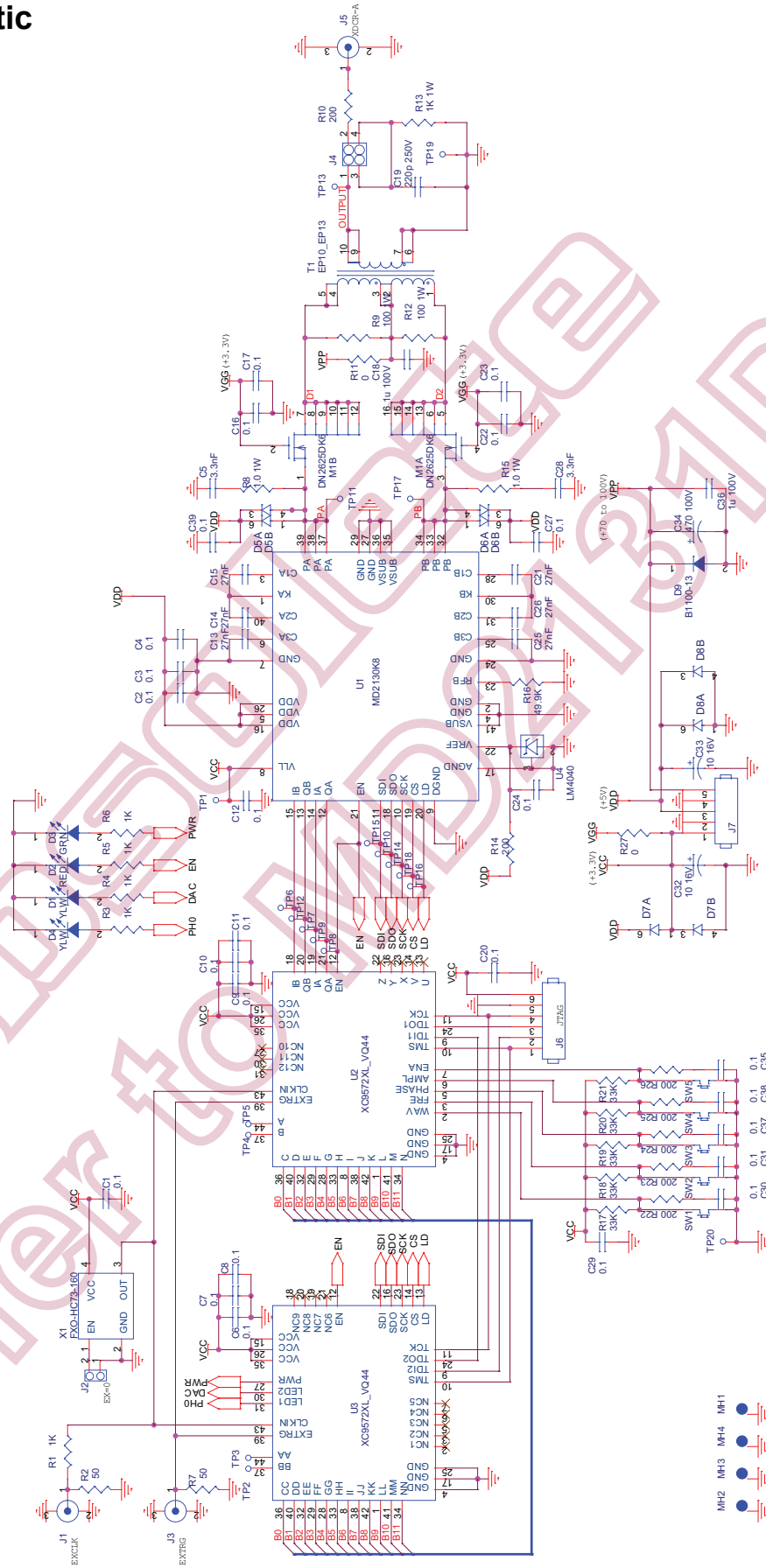

PCB Layout

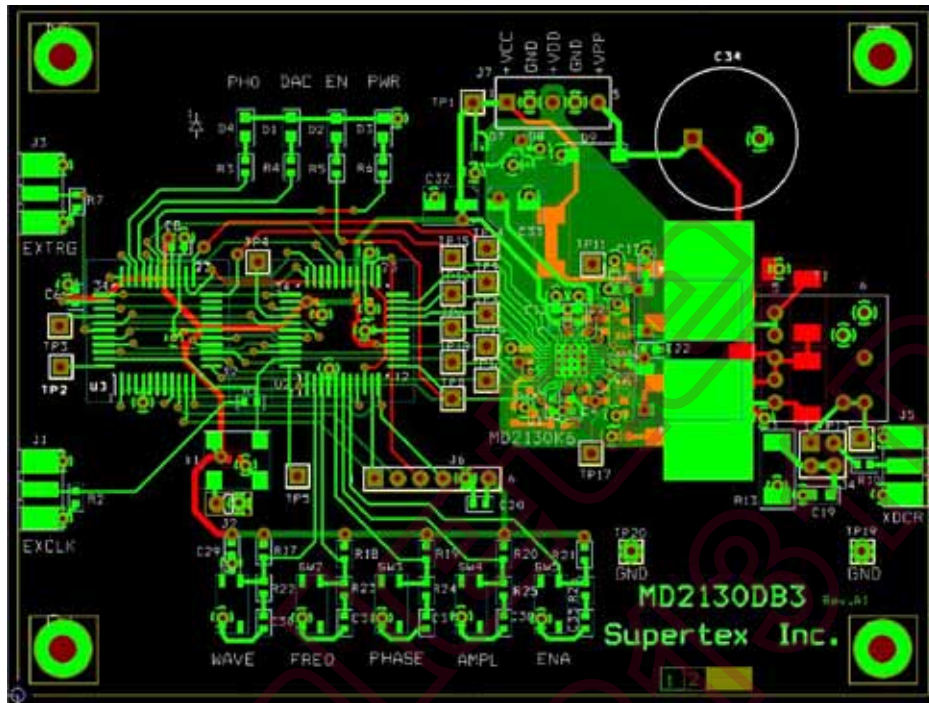

MD2130DB3

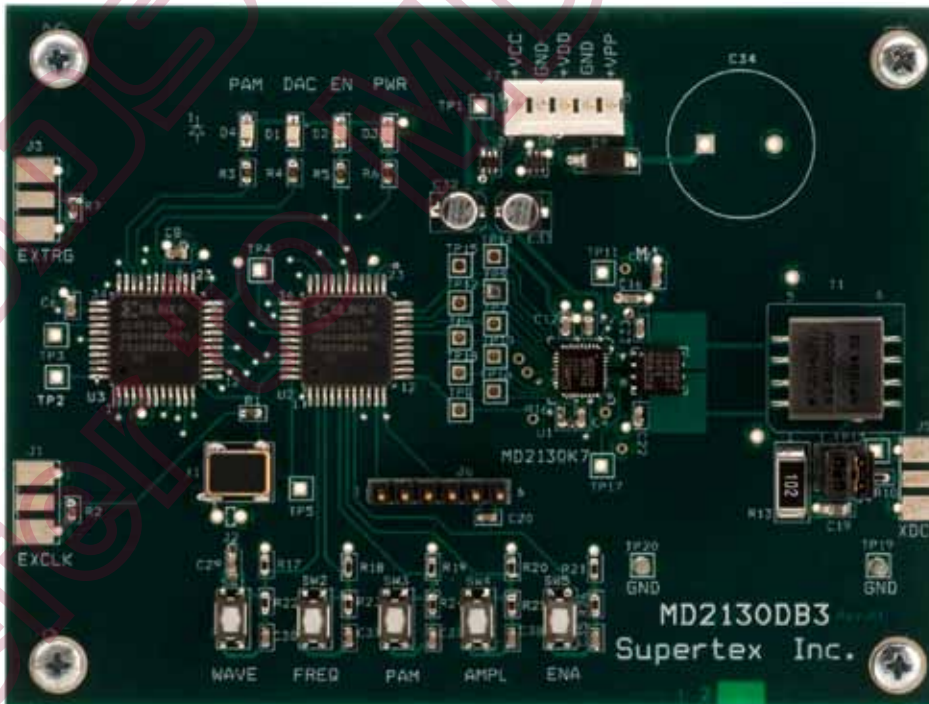

Actual Dimensions: 10.2cm x 7.6cm (4.00" x 3.00")

MD2130DB3 Input and Output Waveforms

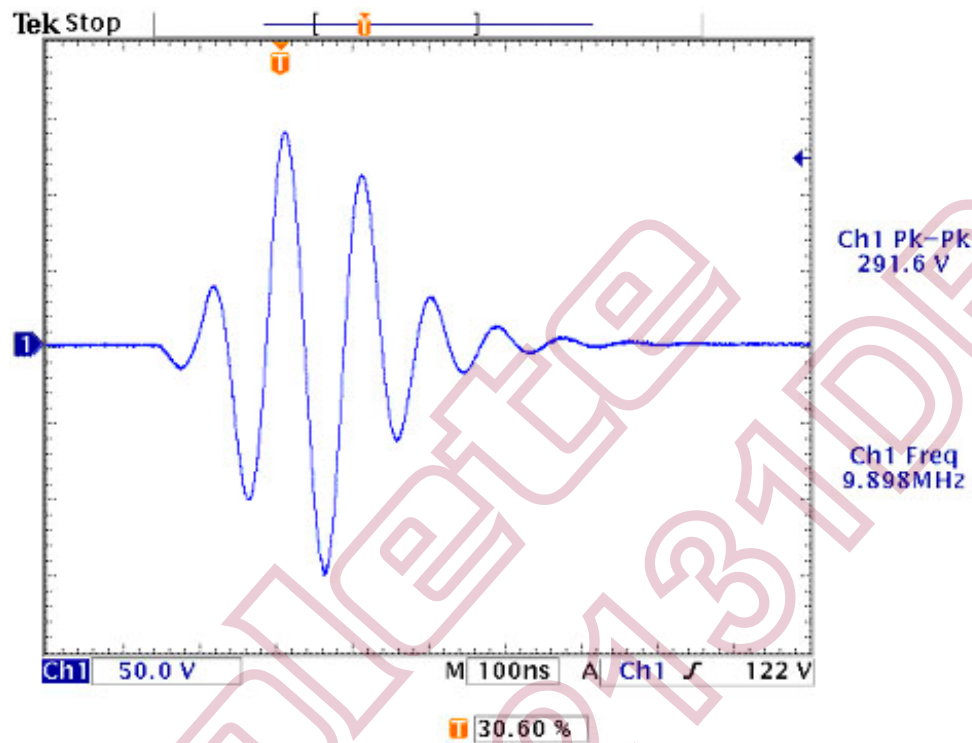

Figure 1:

The output waveforms of 16-sample/cycle at 10MHz, 135deg, DAC = 255, $V_{pp} = 100V$, 220pF//1kΩ load.

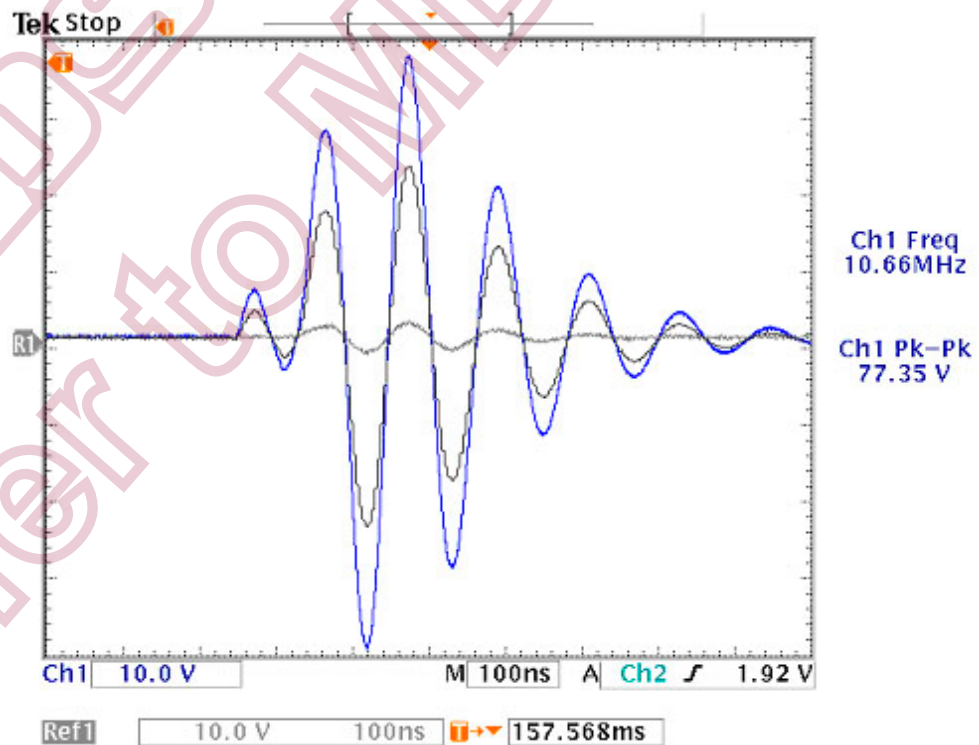

Figure 2:

The output waveforms of 8-sample/cycle at 10MHz, 45deg, DAC Range = 4 - 68, $V_{pp} = 100V$, 220pF//1kΩ load.

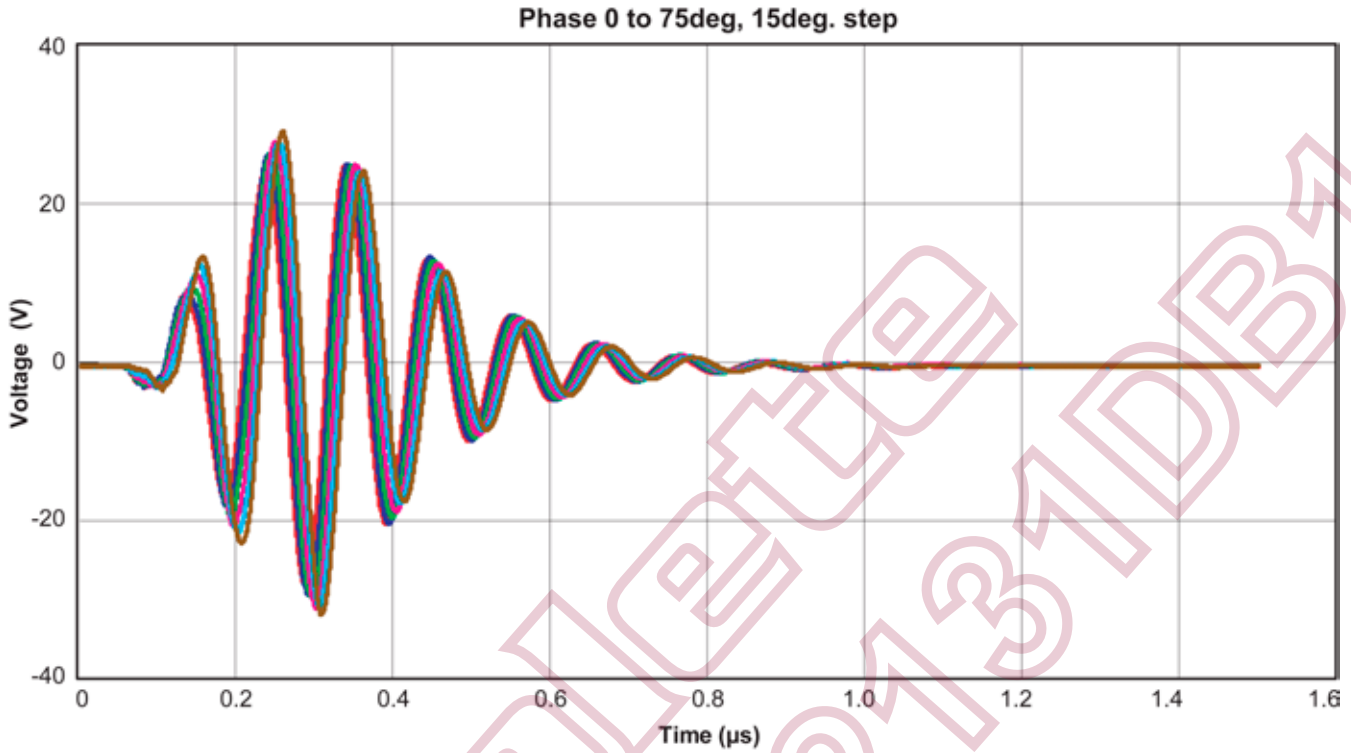

Figure 3:
The output waveforms of phase angle 0, 15, 30 ... 75 deg.

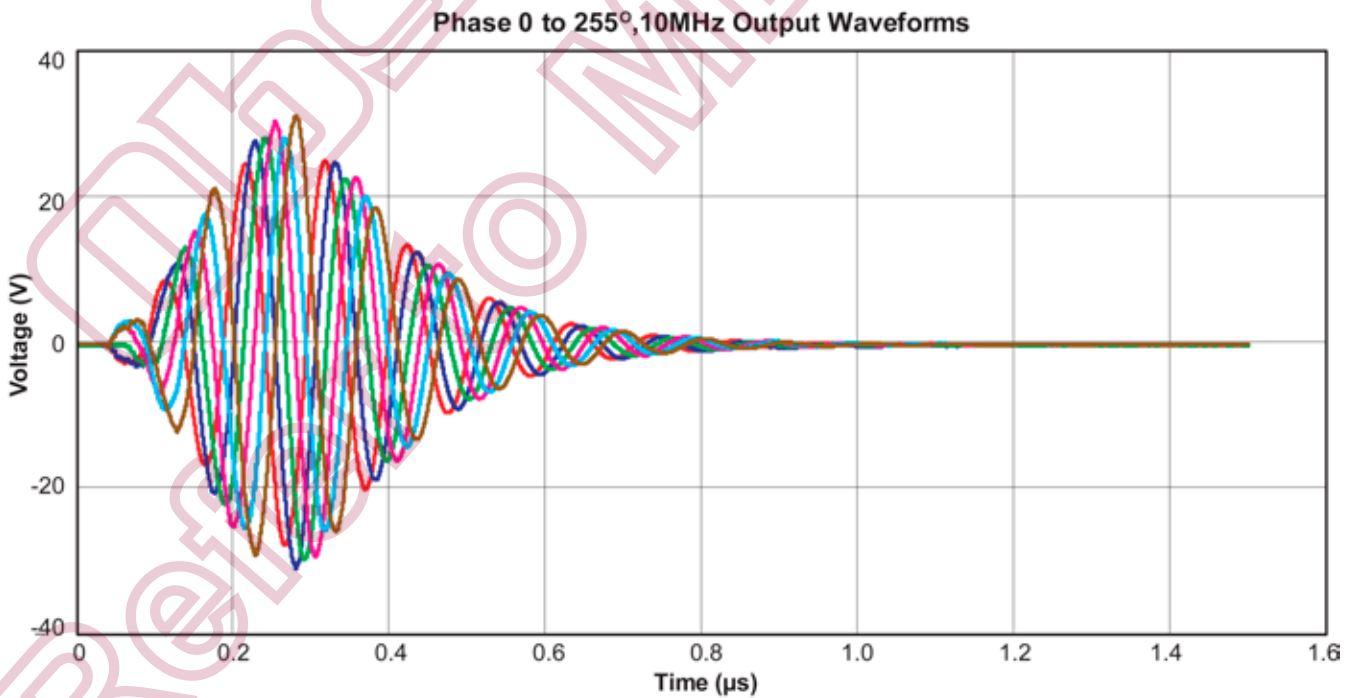

Figure 4:
The output waveforms of phase angle 0, 45, 90... 255 deg.

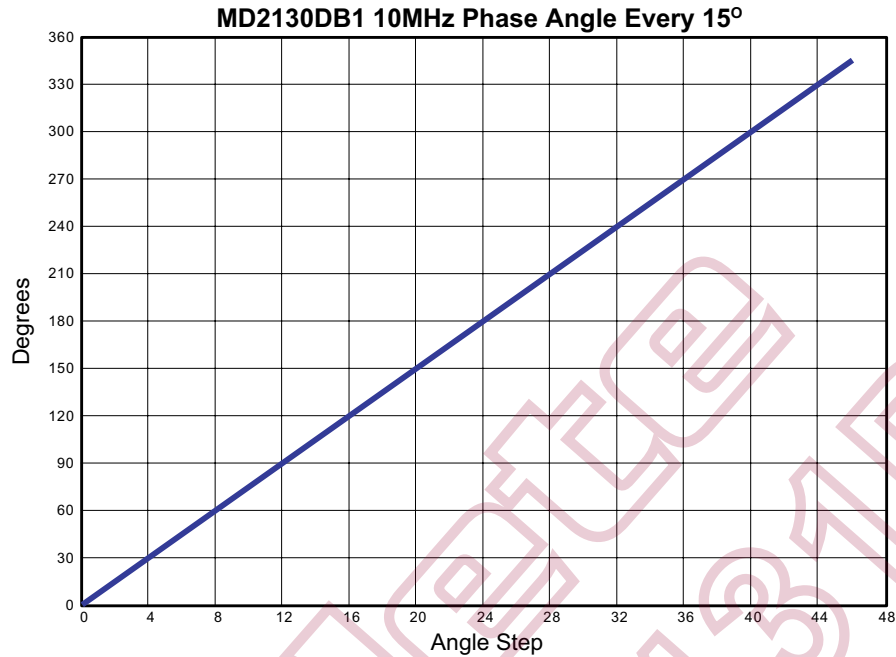

Figure 5:

The phase angle measurements of 10MHz, 15 deg/step from 24 traces of 10,000 data points FFT. The maximum MD2130 phase angular resolution is 7.5deg.

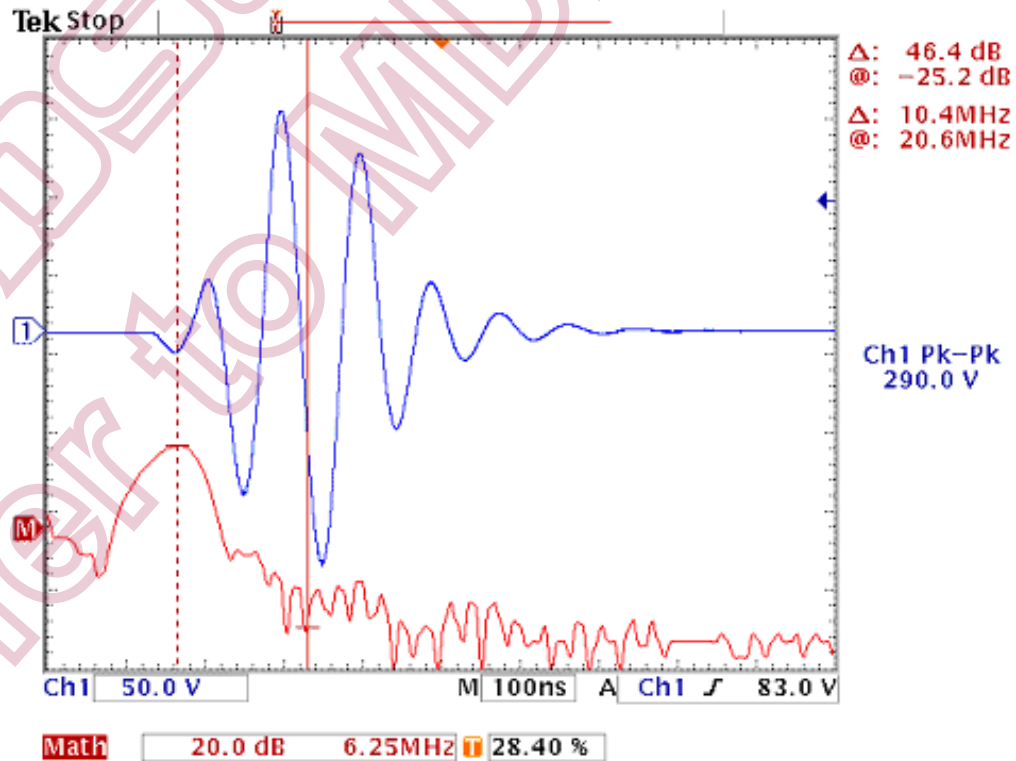

Figure 6:

The 10MHz 16 sample/cycle output waveform and FFT (Math) results at 10MHz and harmonics, 220pF//1kΩ load.

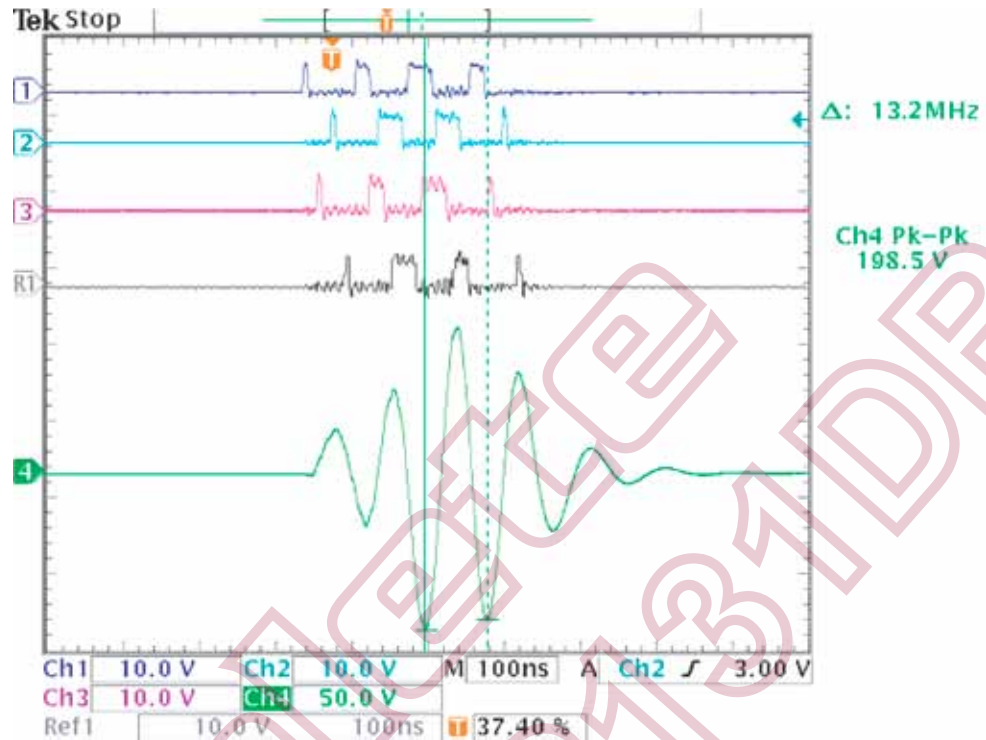

Figure 7:

Input IA, IB, QA, QB and load waveform of RF 13.3 MHz, 12-sample/cycle, 160MHz PWM.

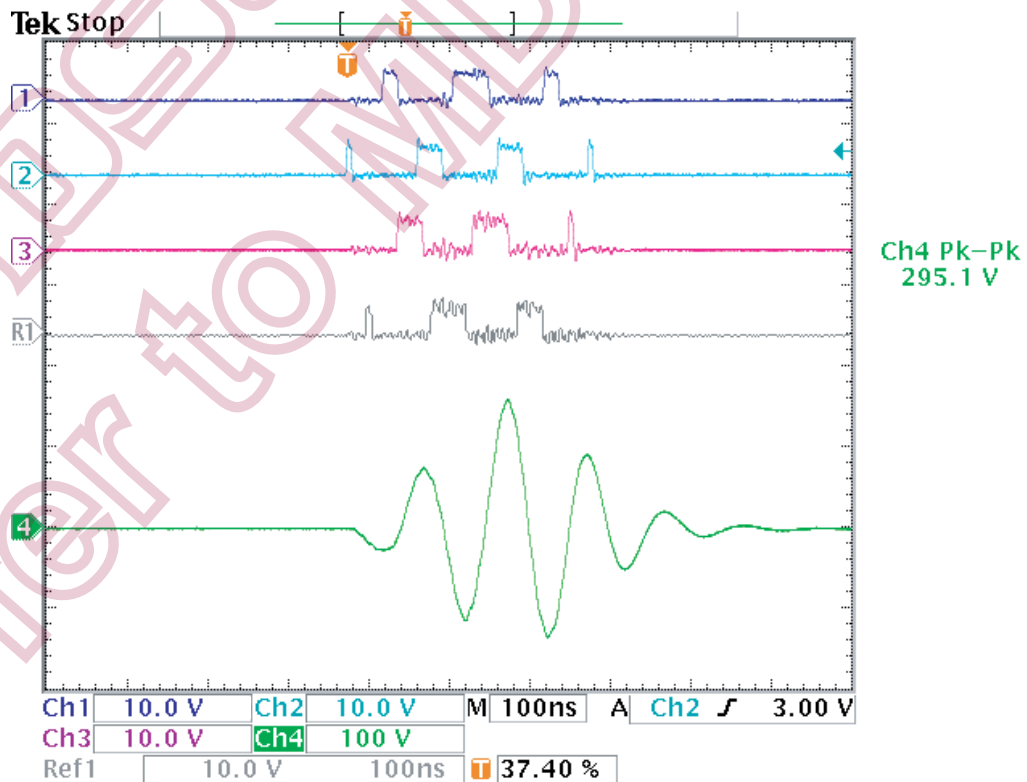

Figure 8:

Input IA, IB, QA, QB and load waveform of RF 10MHz, 16-sample/cycle, 160MHz PWM.

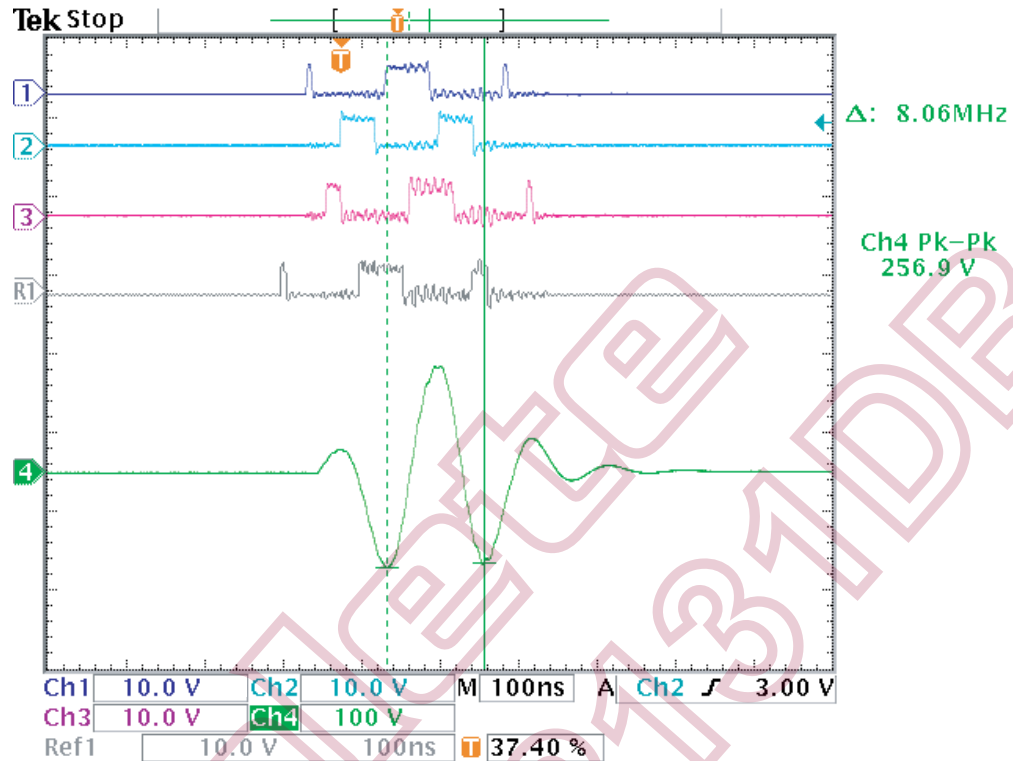

Figure 9:

Input IA, IB, QA, QB and load waveform of RF 8.0MHz, 20-sample/cycle, 160MHz PWM..

Output Waveform Frequency Selection Table

Output Frequency	Samples / Cycle of Ultrasound Output Waveform			Note:
	12 s/c	16 s/c	20 s/c	
Frequency	13.3MHz	10.0MHz	8.0MHz	$f_{CLKIN} = 160MHz$

Output Waveform Phase Angle Selection Table

Phase Angle Steps (PHASE Button)					Note
0	1	...	24	47	
0 (power-on, LED1 on)	7.5	...	180	352.5	Output Phase Angle Degree
				48	

Output Waveform Amplitude Selection Table

Amplitude Steps (AMPL Button)					Note
0	1	...	8	15	
0	16	...	128 (power-on, LED2 on)	240	DAC Register Value
				16	

Board Connector and Test Pin Description

CPLD Pin #	Signal Name	Description
U2,3-15,26,35	VLL	Logic Power Supply +3.3V
U2,3-4,17,25	GND	Logic Power Ground 0V
U2-2	WAV	Run or stop demo waveform phase
U2-3	FRE	Selecting frequency: 8,10 and 13.3MHz
U2-5	PHASE	Single step phase change, Angle stepping:0, 7.5, 15...360
U2-6	AMPL	Single step amplitude change, DAC stepping: 15, 31...255
U2-7	ENA	Control MD2130 EN pin
U2-18	IA	Output signal to MD2130 IA
U2-19	IB	Output signal to MD2130 IB
U2-20	QA	Output signal to MD2130 QA
U2-21	QB	Output signal to MD2130 QB
U3-31	LED1	Output signal Yellow, PH0 LED is on when Phase = 0
U3-30	LED2	Output signal Yellow, DAC LED is on when DAC = 127
U3-27	PWR	Output signal LED Green, indicates +3.3V power supply on
U2,3-10	TMS	Test Mode Select of JTAG
U2,3-9	TDI	Test Data In of JTAG, two CPLD in daisy chain
U2,3-24	TDO	Test Data Out of JTAG, two CPLD in daisy chain
U2,3-11	TCK	Test Clock of JTAG
U2,3-43	CLK	CPLD clock input
U2,3-39	EXTRG	External trigger signal input to control waveform timing
U2,3-12	EN	Output signal LED Red, indicates MD2130 is enabled
U3-22	SDI	Output signal to MD2130 SDI
U3-16	SDO	Input signal from MD2130 SDO
U3-23	SCK	Output signal to MD2130 SCK
U3-14	CS	Output signal to MD2130 CS
U3-13	LD	Output signal to MD2130 LD
All remaining pins	-	NC or Reserved

CPLD Programming Connector

JTAG Pin #	Signal Name	Description
J6-1	TMS	Test mode select of CPLD
J6-2	TDI	Test data In of CPLD
J6-3	TDO	Test data out of CPLD
J6-4	TCK	Test clock of CPLD
J6-5	GND	Logic power supply ground 0V for programming only
J6-6	V _{CC}	Logic power supply +3.3V for programming only

Test Signal Connector

SMA & Jumper	Signal Name	Description
J1	EXCLK	External clock input when on-board oscillator is disabled, or output the clock when it is enabled
J2	OSC_EN	Jumper for on-board oscillator, short = disable, open = enabled
J3	EXTRG	External trigger signal input, 0V to 3.3V Square Wave, 10KHz to 40KHz only
J4	Load JP	Jumper for on-board RC load to MD2130DB3 high voltage output and XDCR connector
J5	XDCR	MD2130DB3 waveform output, for SMA-cable to oscilloscope, high voltage! 0 to +/-350Vp-p max

Power Supply Connector

Power Supply Pin #	Signal Name	Description
J7-1	V _{CC}	+3.3V, CPLD control logic supply voltage with current limit to 250mA
J7-2	GND	Ground reference, 0V
J7-3	V _{DD}	+5V MD2130 positive supply voltages with current limit to 50mA
J7-4	GND	Ground reference, 0V
J7-5	V _{PP}	+70 to 100V, the high voltage supply with current limit to 30mA

Voltage Supply Power-Up Sequence

Step	Signal Name	Description
1	V _{DD}	+5.0, MD2130 positive supply voltages
2	V _{CC}	+3.3V, MOSFET gate biasing and CPLD control logic supply voltage
3	V _{PP}	+70V to 100V, the high voltage supply
4	EN Logic Active	Enable logic control, active-high signal to MD2130

Power-Down

1	EN Logic Active	Disable logic control, active-high signal to MD2130
2	V _{PP}	+70V to 100V, the high voltage supply, off
3	V _{DD}	+5V, MD2130 positive supply voltages with all input signals LOW, off
4	V _{CC}	+3.3, CPLD control logic supply voltage with EN=0, off

MD2130DB3 Bill of Materials

Reference	Description	Manufacturer	Manufacturer's Part Number
C1-12...	CAP .1 μ F 25V Ceramic X7R 0603	NA	Any
C13,14,15...	CAP .027 μ F 50V Ceramic X7R 0603	ECJ-1VB1H273K	Panasonic
C18, C36	CAP Ceramic 1 μ F 100V X7R 20% 1210	C3225X7R2A105M	TDK
C19	CAP Ceramic 220PF 200V NP0 0805	ECJ-2YC2D221J	Panasonic
C32, C33	CAP 10 μ F 16V Elect WT SMD	UWT1C100MCL1GB	Nichicon
C5, C28	CAP Ceramic 3300PF 10% 100V X7R 0603	06031C332KAT2A	AVX
C34	CAP 470 μ F 100V Elect VR Radial	UVR2A471MHD	Nichicon
D1-4	LED Red, Green, Yellow DIFF 0805 SMD	NA	Any
D9	Diode Schottky 100V 1A SMA	B1100-13	Diodes Inc
D5-8	Diode Schottky Dual 30V SOT-363	BAT54DW-7	Diodes Inc
M1	Depletion 250V 3.0A N-MOSFET IN 8-Lead DFN	DN2625DK6	Supertex Inc
R1-4...	Res 1/16W 1% 0603 SMD	NA	Any
R8,9,12,15	Res 1W 1% 2512 SMD	NA	Any
T1	$L_w = 22\mu$ H, 1:1:1 wideband ultrasound pulse transformer	750340727	Würth Electronics
U1	IC Ultrasound Beamforming Source Driver 5x5mm QFN-40	MD2130K7	Supertex Inc.
U2, U3	IC CPLD 72 MCELL C-Temp 44-VQFP	XC9572XL-5VQ44C	Xilinx
U4	IC Prec Micropwr Ref SOT-23	LM4040DEM3-2.5	National
X1	OSC Clock 160.000 mHZ 3.3V SMD	JITO-2-DC3AE-160	FOX Electronics

Supertex inc. does not recommend the use of its products in life support applications, and will not knowingly sell them for use in such applications unless it receives an adequate "product liability indemnification insurance agreement." **Supertex inc.** does not assume responsibility for use of devices described, and limits its liability to the replacement of the devices determined defective due to workmanship. No responsibility is assumed for possible omissions and inaccuracies. Circuitry and specifications are subject to change without notice. For the latest product specifications refer to the **Supertex inc.** (website: <http://www.supertex.com>)